

Rohnson

Air Fryer

Instruction Manual

Model: R-2867



General description

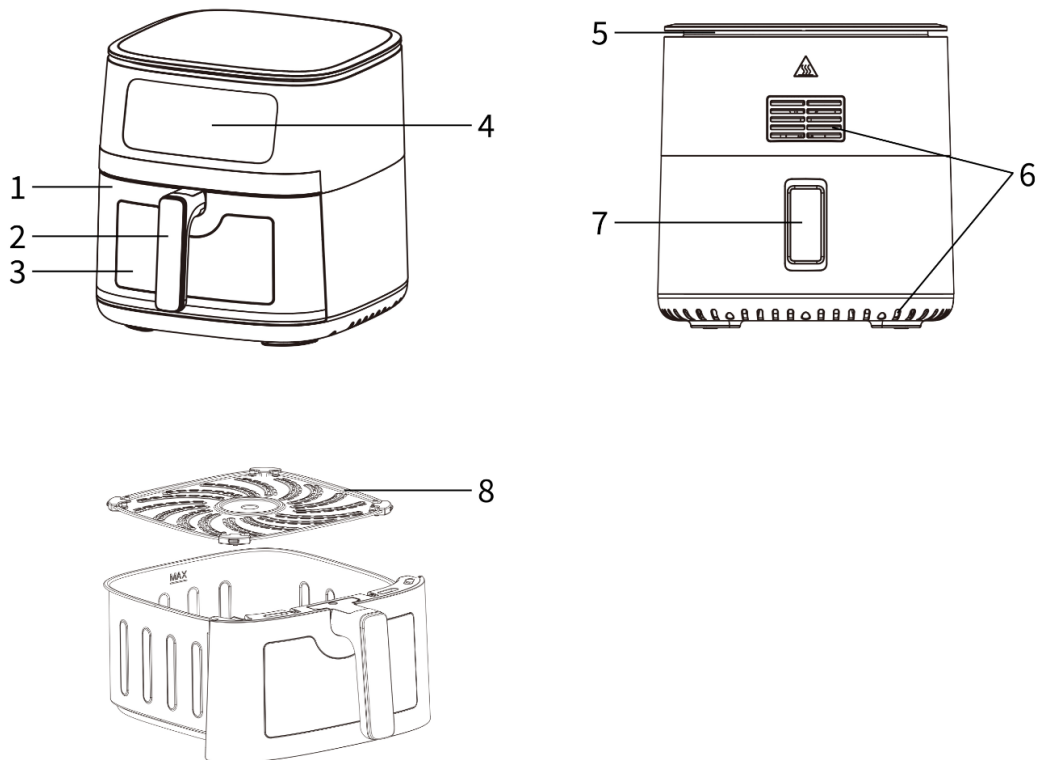

- | | |
|-----------------------|--------------------------------|
| 1. Basket | 2. Basket handle |
| 3. Transparent window | 4. Digital Touch Control Panel |
| 5. Air inlet | 6. Air outlet openings |
| 7. Mains cord | 8. Frying tray |

Attaching the fry basket handle:

The fry basket handle might come disassembled in your appliance's packaging. To attach the fry basket handle:

- Remove the paper label. Pull the fry basket out of the appliance.
- Slide the attachment point on the handle downward until it clicks into place.

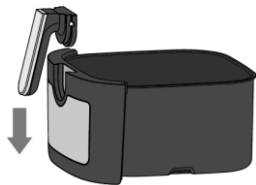

-The fry basket handle should lock into place and should not detach once it is locked into place.

Removing the fry basket handle:

To remove the fry basket handle:

- Use a tool, such as a screwdriver, to lift the silicone on the fry basket handle. Align the tool with the hole and push down, then tilt the tool inward.

Grab the handle with your hand and pull it out. Done.



Inserting

Place the fry tray in the basket.

Slide the basket into the appliance. If the basket is placed properly, it will click into place.

NOTE: This appliance cooks using hot air. Do not fill the basket with oil or frying fat.

Significance

Please read this manual carefully before using the appliance as damage may occur under incorrect operations. Pls keep this manual for future reference.

Danger

- Do not immerse the housing in water or rinse under the tap due to the multi-electrical and heating components.
- Do not let liquid enter the appliance to prevent electric shock or short-circuit.
- Keep all ingredients in the basket to prevent any contact from heating elements.
- Do not cover the air inlet and the air outlet when the appliance is working.
- Filling the pan with oil may cause a fire hazard.
- Do not touch the inside of the appliance while it is operating.

Warning

- Check if the voltage indicated on the appliance fits the local power voltage.
- Do not use the appliance if there is any damage on plug, power cord or other parts.
- Do not go to any unauthorized person to replace or fix a damaged power cord.
- Keep the appliance and its power cord out of the reach of children.
- Keep the power cord away from hot surfaces.
- Do not plug the appliance or operate the control panel with wet hands.
- Always make sure that the plug is inserted into the wall socket properly.
- Do not connect appliance to an external timer switch.
- Do not place the appliance on or near combustible materials such as a tablecloth or curtain.
- Do not place the appliance against a wall or against other appliance. Leave at least 10cm free space on the back and sides and 10cm free space above the appliance.
- Do not place anything on top of the appliance.

- Do not use the appliance for any other purpose than described in this manual.
- Do not leave the appliance unattended.
- During hot air frying, hot steam is released through the air outlet openings. Keep your hands and face at a safe distance from the steam and from the air outlet openings. Also be careful of hot steam and air when you remove the pan from the appliance. Any accessible surfaces may become hot during use.
- Immediately unplug the appliance if you see dark smoke coming out of the appliance. Wait for the smoke emission to stop before you remove the pan from the appliance.

Caution

- Ensure that appliance is placed on a horizontal, even and stable surface.
- This appliance is designed for household use only. It is not suitable to be safely used in environments such as staff kitchens, farms, motels, and other non-residential environments.
- The warranty is invalid if the appliance is used for professional or semi-professional purposes, or it is not used according to instructions. (Never use the appliance when the plug is damaged.)
- The appliance needs approximately 30 minutes to cool down before it is safe to handle or clean.

Automatic switch-off

The appliance has a built-in timer, it will automatically shut down the appliance when count down reaches zero. You can manually switch off the appliance by pressing off button, it will automatically shut down the appliance in 20 seconds.

Before first use

1. Remove all packaging materials and stickers or labels.
2. Clean the basket and rack with hot water, with some washing liquid and a non-abrasive sponge. These parts are safe to be cleaned in dishwasher.
3. Wipe inside and outside of the appliance with a clear cloth. And there is no need to fill the basket with oil and frying fat as the appliance works on hot air.

Using the appliance

1. Connect the mains plug into an earthed wall socket.
2. Carefully pull the basket out of the air fryer.
3. Place the ingredients in the basket.
4. Slide the basket into the air fryer.

Note: Do not exceed the MAX indication (see section “settings” in this chapter), as it may affect the cooking quality of the food.

Caution: Do not touch the basket during and in short time after use, as it gets very hot. Only hold the basket by the handle.

5. Do not fill the basket with oil or any other liquid.
6. Finger touch Power on/off.
7. Finger touch Menu to choose functions (totally 12 functions).

Control panel presentation



Note: 12 functions are provided: Fries, Wings, Steak, Fish, Toast, Chicken, Shrimps, Cake, Egg Tart, Cookies, Bacon and Pizza. You can use Menu button  to choose different cooking food you like.

Menu presetting:



Menu	Icon Button	Default Temp	Default Time	Shake
Default	/	185°C	15min	/
Fries	/	200°C	23min	Shake
Wings	/	180°C	19min	Shake
Steak	/	200°C	12min	Shake
Fish	/	195°C	10min	/
Toast	/	160°C	10min	Shake
Chicken	/	200°C	30min	Shake
Shrimps	/	200°C	20min	Shake
Cake	/	160°C	30min	/
Egg Tart	/	165°C	30min	/
Cookies	/	160°C	20min	Shake
Bacon	/	175°C	12min	Shake
Pizza	/	185°C	8min	/
Temp Range	80°C~200°C	/	/	/
Time Range	1min~60min	/	/	/

After touching menu button, you can choose menu you like. After choosing the function, please finger Start/Pause button  to start cooking.

During the cooking process, if you want to adjust time or temperature, you can increase or decrease both cooking Time at 1 Minute intervals and Temperature at 5°C

intervals by continues touching the  keys at either side of the respective Time and Temperature icons or fast scroll by holding keys down to set your desired cooking Time/Temperatures.

Note: Start/Pause button : During the hot air frying process, the fan indicator light will be running, then if press this button, the fan indicator light will be blinks. Here, this button acts as pause function. In the pause state, you can change menu to choose other presetting. Then, you press this button again, the air fryer will continue cooking. Here, this button acts as re-start function.

Menu button : Touch this button to choose different cooking functions. After you choose the menu, press the start button. When during the cooking period, for example, you want to change fries to cake, then first press the Pause button , then touching the menu button to switch to different cooking function.

Light button: Touch this button , the inside light will be up. Touch this button again and the light will be off. The light will automatically turn off 60 seconds later.

Shake indicator : The shake indicator will illuminate when the cooking cycle has reached its halfway point. This halfway time gives you the opportunity to shake or flip your food in appliance, which helps ensure even cooking.

Note: If you do not remove the basket and shake the food, the shake light on the control panel will remain illuminated.

8. Some ingredients require to shake halfway during the preparation time (see section 'settings' in this chapter). By this way, pull the basket out of the appliance by the handle and shake it. Then slide the basket back into the air fryer.

9. Machine will have Auto ready bell after cooking. When you hear bell for 5 times, this means the cooking cycle is finished. Pull the basket out of the appliance and place it on the heat-resistant holder.

Note: After the time ends, the heating element stops working, but the fan will continue to run about 20 seconds to blow away the hot air as safety. Finally, the timer bell will ring for 5 times as the ending alarm.

10. Check if the ingredients are ready.

Note: If the ingredients are not ready yet, simply slide the basket back into the appliance. Press the temperature control button to adjust Temperature setting and press the Timer control button to adjust time setting. And then press the Start button to run the appliance.

11. To remove ingredients, (e.g. beef, chicken, meat, any ingredients with original oil and will have excess oil from ingredients collected on the bottom of the basket), please use tongs to pick ingredients one by one.

Note: Be careful if you want to turn the basket over, the oil collected on the bottom of the basket will leak onto the ingredients.

12. To remove ingredients (e.g. chips, vegetable or ingredients with no excess oil from the ingredients), please turn over the basket, and pour ingredients to tableware.

Tip: To remove large or fragile ingredients, lift the ingredients out of the basket by a pair of tongs.

13. When a batch of ingredients is ready, the fryer is instantly ready for preparing another batch.

Settings

This table below will help you to select the basic settings for the ingredients.

Note: Keep in mind that these settings are indications. As ingredients differ in origin, size, shape and brand, we cannot guarantee the best setting for your ingredients.

Because the Rapid Air technology reheats the air inside the appliance instantly, pull the basket briefly out of the appliance during hot air frying barely disturbs the process.

	Min-Max (g)	Time (Min)	Temp °C	Shake	Remark
French fries					
Thin frozen fries	300-700	9-16	200	Y	
Thick frozen fries	300-700	11-20	200	Y	
Home-made fries (8X8mm)	300-800	10-16	200	Y	Add 1/2 tbsp of oil
Homemade potato wedges	300-800	18-22	180	Y	Add 1/2 tbsp of oil
Home-made potato cubes	300-750	12-18	180	Y	Add 1/2 tbsp of oil
	250	15-18	180	Y	
Potato gratin	500	15-18	200	Y	
Steak	100-500	8-12	180		
Meat chops	100-500	10-14	180		
Hamburger	100-500	7-14	180		
Sausage roll	100-500	13-15	200		
Drumsticks	100-500	18-22	180		
Chicken breast	100-500	10-15	180		
Snacks					
Spring rolls	100-400	8-10	200	Y	Use oven-ready
Frozen chicken nuggets	100-500	6-10	200	Y	Use oven-ready
Frozen fish fingers	100-400	6-10	200		Use oven-ready
Frozen bread crumbed	100-400	8-10	180		Use oven-ready
Stuffed vegetables	100-400	1-10	160		

Cake	300	20-25	160		Use baking tin
Quiche	400	20-22	180		Use baking tin/oven dish
Muffins	300	15-18	200		Use baking tin
Sweet snacks	400	1-20	160		Use baking tin/oven dish

Tips

- Small ingredients usually require a slightly shorter preparation time than larger ingredients.
- A larger amount of ingredients only requires a slightly longer preparation time, a smaller amount of ingredients only requires a slightly shorter preparation time.
- Shaking smaller ingredients halfway during the preparation time optimizes the result and can help prevent unevenly fried ingredients.
- Add some oil to fresh potatoes and fry your ingredients for another few minutes then for a crispy result.
- Do not prepare extremely greasy ingredients such as sausages in the air fryer.
- Snacks can be prepared in an oven can also be prepared in the air fryer.
- The optimal amount for prepare crispy fries is 500 grams.
- Use pre-made dough to get snacks quickly and easily. Pre-made dough also requires a shorter preparation time than home-made dough.
- Please a baking tin or oven dish in the fryer basket if you want to bake a cake or quiche or if you want to fry fragile ingredients or filled ingredients.
- You can also use the air fryer to heat ingredients. To heat ingredients, set the temperature to 150°C for up to 10 minutes.

Making home-made fries

To make home-made fries, follow the steps below:

1. Peel and slice the potatoes.
2. Wash the potato sticks thoroughly and dry them with kitchen paper.
3. Pour 1/2 tablespoon of olive oil in a bowl, put the sticks on top and mix until the sticks are coated with oil.
4. Remove the sticks from the bowl with your fingers or a kitchen utensil so that excess oil stays behind in the bowl. Put the sticks in the basket.
5. Fry the potato sticks according to the instructions in this chapter.

Cleaning

Clean the appliance after every use.

Do not clean the pan, basket and the inside of the appliance by metal kitchen utensils or abrasive cleaning materials, as this may damage the non-stick coating of them.

Remove the mains plug from the wall socket to make the appliance cool down.

Note: Remove the basket to let the fryer cool down more quickly.

Wipe the outside of the appliance with a moist cloth.

Clean the basket and rack with hot water, some washing-up liquid and a non-abrasive sponge.

You can remove any remaining dirt by degreasing liquid.

Note: The basket and rack are dishwasher-proof.

Tip: If dirt is stuck to the rack or the bottom of the basket, fill the basket with hot water with some washing-up liquid. Put the rack in the basket and let them soak for about 10 minutes.

Clean the inside of the appliance with hot water and non-abrasive sponge.

Clean the heating element with a cleaning brush to remove any food residues.

Storage

1. Unplug the appliance and let it cool down thoroughly.
2. Make sure all parts are clean and dry.

Troubleshooting

Problem	Possible cause	Solution
The AIR FRYER does not work.	The appliance is not plugged in.	Put the mains plug in an earthed wall socket.
	You haven't pressed the start button.	Press the start/power button after you set the temp&time or choose the quick recipe.
The ingredients fried with the AIR FRYER are not done.	The amount of ingredients in the basket is too big.	Put smaller batches of ingredients in the basket. Smaller batches are fried more evenly.
	The set temperature is too low.	Turn the temperature to the required Temperature setting.
The ingredients are fried unevenly in the AIR FRYER.	Certain types of ingredients need to be shaken halfway through the preparation time.	Ingredients that lie on top of or across each other (e.g. fries) need to be shaken halfway through the preparation time.
Fried snacks are not crispy when they come out of the AIR FRYER.	You used a type of snacks meant to be prepared in a traditional deep fryer.	Use oven snacks or lightly brush some oil onto the snacks for a crisper result.
I can't slide the basket into the appliance properly.	There are too many ingredients in the basket.	Do not fill the basket beyond the MAX indication.
White smoke Comes out from the Appliance.	You are preparing greasy ingredients.	When you fry greasy ingredients in the AIR fryer, a large amount of oil will leak into the basket. The oil produces while smoke and the basket may heat up More than usual. This does not affect the appliance or the result.

	The basket still contains grease residues from previous use.	White smoke is caused by grease heating up in the basket. Make sure you clean the basket properly after each use.
Fresh fries are fried Unevenly in the AIR FRYER.	You did not use the right potato type.	Use fresh potatoes and make sure that they stay firm during frying.
	You did not rinse the potato sticks properly before you fried them.	Rinse the potato sticks properly to remove starch from the outside of the sticks.
Fresh fries are not crispy when they come out of the AIR FRYER.	The crispiness of the fries depends on the amount of oil and water in the fries.	Make sure you dry the potato sticks properly before you add the oil.
		Cut the potato sticks smaller for a crispier result.
		Add slightly more oil for a crisper result.



IMPORTANT INFORMATION FOR CORRECT DISPOSAL OF THE PRODUCT IN ACCORDANCE WITH EC DIRECTIVE 2012/19/EU.

At the end of its working life, the product must not be disposed of as urban waste. It must be taken to a special local authority differentiated waste collection center or to a dealer providing this service. Disposing of a household appliance separately avoids possible negative consequences for the environment and health, deriving from inappropriate disposal and enables the constituent materials to be recovered to obtain significant savings in energy and resources. As a reminder of the need to dispose of household appliances separately, the product is marked with a crossed-out wheeled dustbin.